

# Installation Manual

## NNR25 Splicing accessories

V1.2

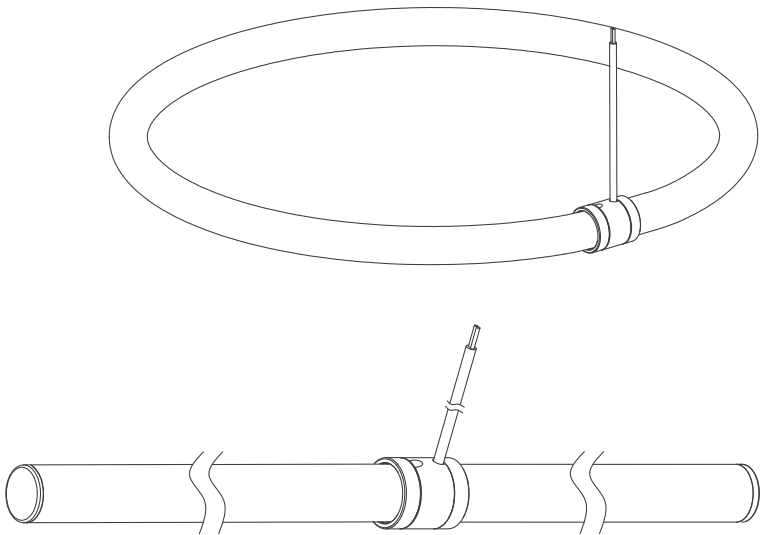

Please read this manual carefully before installation, and install the product in the correct way.  
Please keep it after reading, so that all users of this product can check it at any time.

## Prepare materials

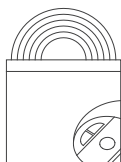

Neon strip



Manual



Countersunk screw

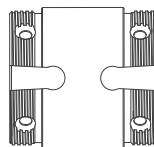

Splicing piece

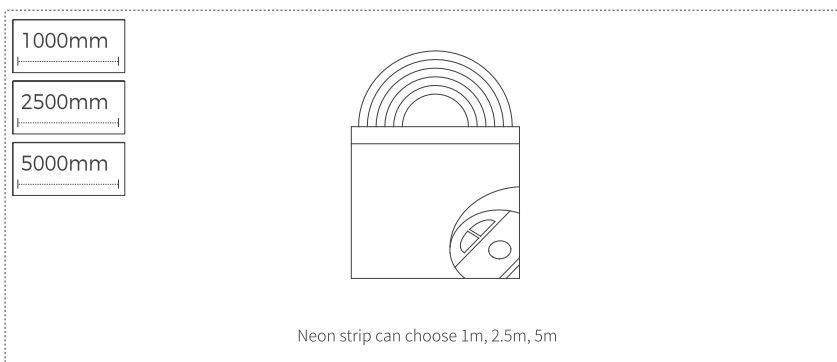

## Installation tools



Phillips  
screwdriver

# Installation Steps

**1** a 2:1 Put the connecting ring into the neon strip

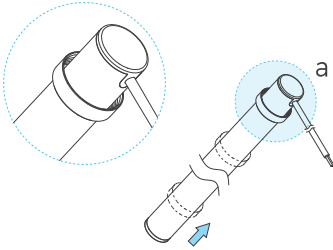

**2** a 2:1

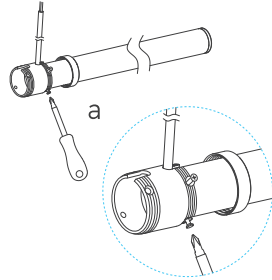

**3** Screw the connecting ring back to the connecting piece

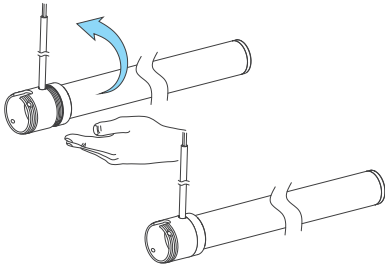

**4** a 2:1

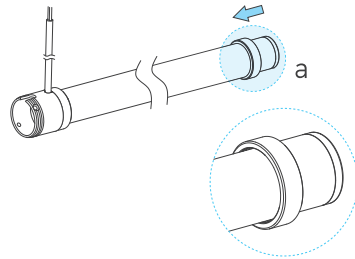

**5** a 3:1

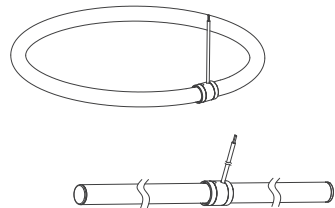
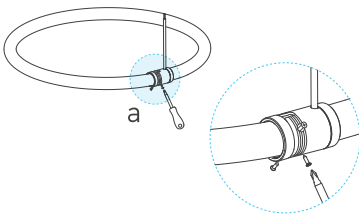



# Parameters

Code	Wire length	Load bearing	Outlet	Adaptation model
				NNR25-XXCSN050CC0100
AS-NNR25DHX-XX	/	4kg	Side	NNR25-XXCSN050CC0250
				NNR25-XXCSN050CC0500



**Tel:** +86-755-2923-1888  
**E-mail:** colors@colorsled.com  
**Web:** www.colorsled.com  
**Add:** Building A5, Qixing Wisdom Park, Shiyan Youth Road,  
Bao'an District, Shenzhen, China

