

Fade-in Fade-out Push+RF LED Dimmer

- Fade-in Fade-out LED dimmer with smooth fading effect for soft start and stop.
- The fading speed can be set via knob potentiometer, 1S, 3S, 5S, 10S, 20S selectable.
- Connect with self-resetting metal button or push switch to achieve on/off and 0-100% dimming function.
- Push input can accept either positive or negative trigger.
- Match with RF 2.4G single zone or multiple zone dimming remote control optional.
- Over-heat / Over-load / Short circuit protection, recover automatically.

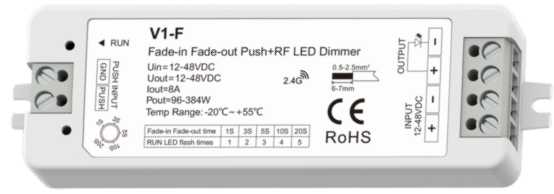

CE RoHS emc RED

Technical Parameters

Input and Output		Dimming data		Safety and EMC	
Input voltage	12-48VDC	Input signal	RF 2.4GHz + Push Dim	EMC standard (EMC)	ETSI EN 301 489-1 V2.2.3 ETSI EN 301 489-17 V3.2.4
Input current	8A	Control distance	30m(Barrier-free space)	Safety standard	EN 61348-1:2015+A1:2021 EN 61348-2-13:2014+A1:2017
Output voltage	12-48VDC	Dimming gray scale	4096 (2 ¹²) levels	Radio Equipment (RED)	ETSI EN 300 328 V2.2.2
Output current	1CH,8A	Dimming range	0 -100%	Certification	CE, EMC, RED
Output power	96-384W	Dimming curve	Logarithmic	Environment	
Output type	Constant voltage	PWM Frequency	2000Hz (default)	Operation temperature	Ta: -20 °C ~ +55 °C
Warranty and Protection		Package		Case temperature (Max.)	Tc: +85 °C
Warranty	5 years	Size	L114 x W38 x H26mm	IP rating	IP20
Protection	recover automatically, Short circuit, Over-heat, Over-load	Gross weight	0.053kg		

Mechanical Structures and Installations

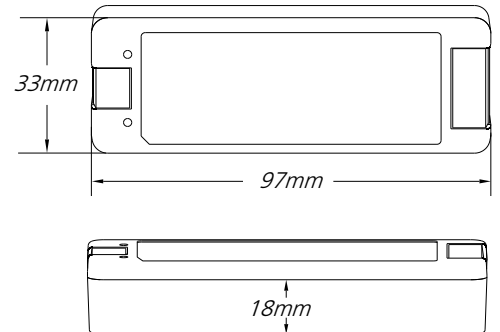
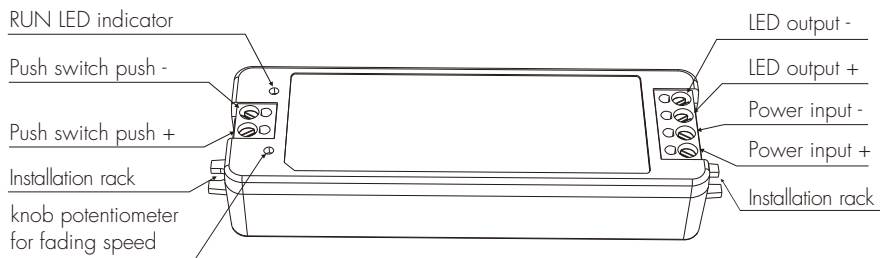

Light on/off fading speed

Rotate knob to switch fading speed, when the fading speed set to 1/3/5/10/20s, the RUN LED indicator will flash 1/2/3/4/5 times.

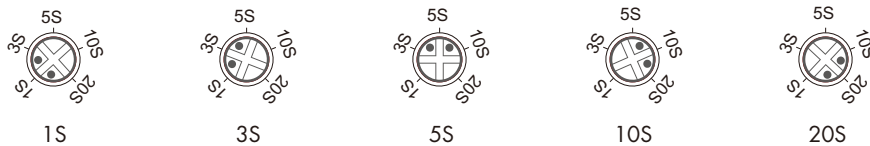

Wiring Diagram

- Connect with self-resetting metal button, positive trigger input. Press the button to switch or adjust brightness, the button indicator always lights up.

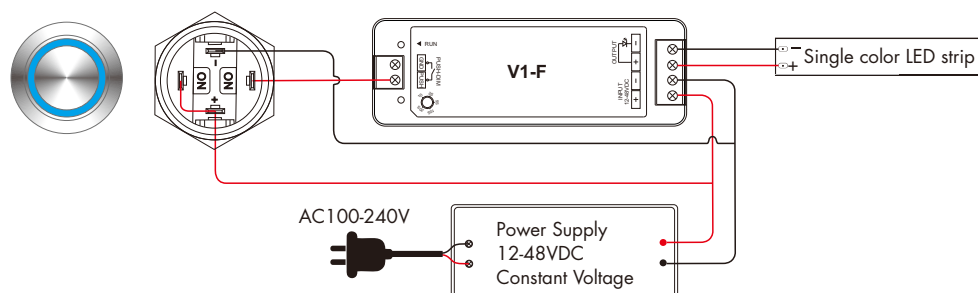

- Connect with self-resetting metal button, positive trigger input.
Press the button to switch or adjust brightness, the button indicator lights up when pressed.

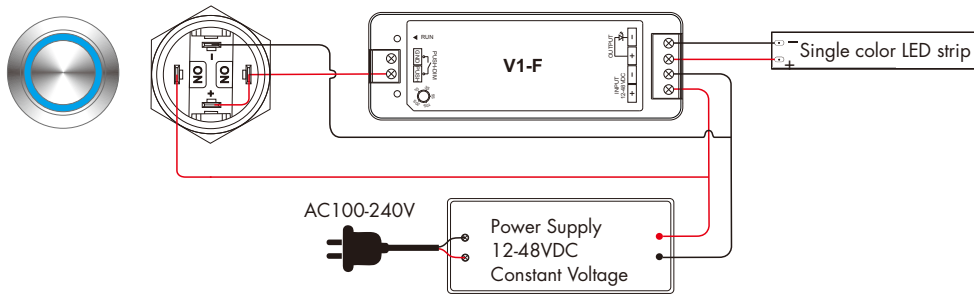

- Connect with self-latching metal button.
Press the button to power on or off the controller, the button indicator lights up when pressed.
Use RF remote to adjust brightness optional.

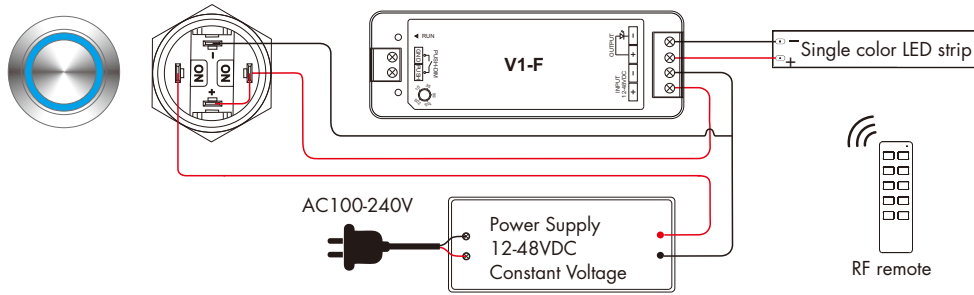

- Connect with push switch panel, negative trigger input.
Press the panel to switch or adjust brightness.

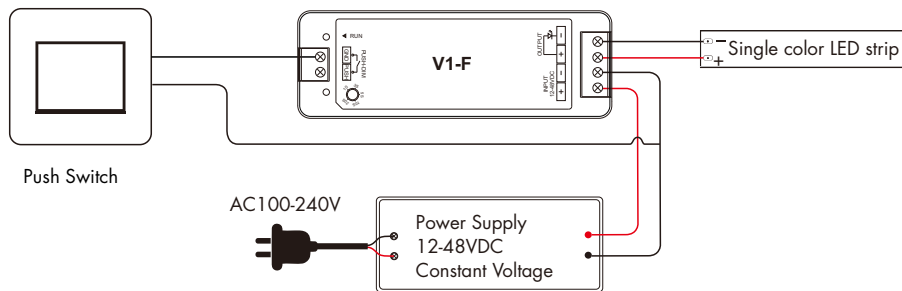

Match Remote Control

Match:

Switch off the power, then switch on power.

Immediately short press on/off key (single zone remote) or zone key (multiple zone remote) 3 times on the remote.

The light blinks 3 times means match is successful.

Delete:

Switch off the power, then switch on power.

Immediately short press on/off key (single zone remote) or zone key (multiple zone remote) 5 times on the remote.

The light blinks 5 times means all matched remotes were deleted.

Push Dim Function

The provided Push-Dim interface allows for a simple dimming method using commercially available non-latching (momentary) wall switch or metal button.

- **Short press:**
Turn on or off light.
- **Long press (1-6s):**
Press and hold to step-less dimming,
With every other long press, the light level goes to the opposite direction.
- **Dimming memory:**
Light returns to the previous dimming level when switched off and on again, even at power failure.
- **Synchronization:**
If more than one controller are connected to the same push switch, do a long press for more than 10s,
then the system is synchronized and all lights in the group dim up to 100%.
This means there is no need for any additional synchrony wire in larger installations.
We recommend the number of controllers connected to a push switch does not exceed 25 pieces,
The maximum length of the wires from push to controller should be no more than 20 meters.

Dimming Curve

